

indoor

# Kotai

## Round dining table / mesa redonda

Mario Ruiz, 2015/2021

T455 100



Structure made of solid wood profile from European oaks. Tabletop made of solid wood from European oaks with 0.83" of section. Also available in European oak veneer. Delivered unassembled.

Estructura fabricada en perfilera maciza de roble europeo. Tapa fabricada en madera maciza de roble europeo de 21 mm de sección. Existe una versión en tablero chapado de roble europeo. Se sirven desmontadas.

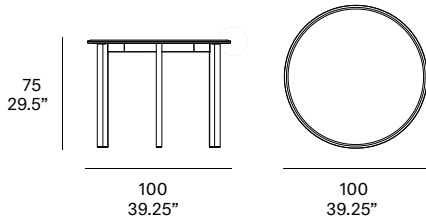

### Shipment details

Qty	1 dining table (1 box)
Volume	0,15 m <sup>3</sup> / 5.3 ft <sup>3</sup>
Gross weight	27 kg / 59.5 lb
Net weight	21 kg / 46.3 lb
Item dimensions (width x depth x height)	100 x 100 x 75 cm 39.25" x 39.25" x 29.5"

Tabletop options:



- single veneered top

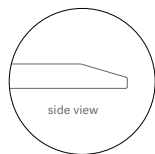

- 21 mm/0.83" thick.

**expormim**

Expormim S.A.  
Pol. Ind. Jaime I  
46640 Moixent (Valencia) Spain  
+34 962 295 144/5  
export@expormim.com  
www.expormim.com

Expormim USA LLC  
(212) 204-8572  
usa@expormim.com  
www.expormim.com

1/2

indoor

**Solid wood / madera maciza**

---



W01 natural oak



W03 light oak



W02 white stained



W04 black stained

**Veneered / tablero chapado**

---



W01 natural oak



W03 light oak



W02 white stained



W04 black stained



**expormim**

Expormim S.A.  
Pol. Ind. Jaime I  
46640 Moixent (Valencia) Spain  
+34 962 295 144/5  
export@expormim.com  
www.expormim.com

Expormim USA LLC  
(212) 204-8572  
usa@expormim.com  
www.expormim.com

indoor

# Kotai

## Round dining table / mesa redonda

Mario Ruiz, 2015/2021

T455 120



Structure made of solid wood profile from European oaks. Tabletop made of solid wood from European oaks with 0.83" of section. Also available in European oak veneer. Delivered unassembled.

Estructura fabricada en perfilera maciza de roble europeo. Tapa fabricada en madera maciza de roble europeo de 21 mm de sección. Existe una versión en tablero chapado de roble europeo. Se sirven desmontadas.

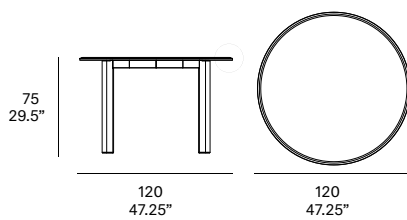

### Shipment details

Qty	1 dining table (1 box)
Volume	0,22 m <sup>3</sup> / 7.8 ft <sup>3</sup>
Gross weight	39 kg /86 lb
Net weight	32 kg / 70.5 lb
Item dimensions (width x depth x height)	120 x 120 x 75 cm 47.25" x 47.25" x 29.5"

Tabletop options:



- single veneered top

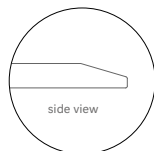

- 21 mm/0.83" thick.

**expormim**

Expormim S.A.  
Pol. Ind. Jaime I  
46640 Moixent (Valencia) Spain  
+34 962 295 144/5  
export@expormim.com  
www.expormim.com

Expormim USA LLC  
(212) 204-8572  
usa@expormim.com  
www.expormim.com

1/2

indoor

**Solid wood / madera maciza**

---



W01 natural oak



W03 light oak



W02 white stained



W04 black stained

**Veneered / tablero chapado**

---



W01 natural oak



W03 light oak



W02 white stained



W04 black stained



**expormim**

Expormim S.A.  
Pol. Ind. Jaime I  
46640 Moixent (Valencia) Spain  
+34 962 295 144/5  
export@expormim.com  
www.expormim.com

Expormim USA LLC  
(212) 204-8572  
usa@expormim.com  
www.expormim.com

indoor

# Kotai

## Round dining table / mesa redonda

Mario Ruiz, 2015/2021

T455 140



Structure made of solid wood profile from European oaks. Tabletop made of solid wood from European oaks with 0.83" of section. Also available in European oak veneer. Delivered unassembled.

Estructura fabricada en perfilaría maciza de roble europeo. Tapa fabricada en madera maciza de roble europeo de 21 mm de sección. Existe una versión en tablero chapado de roble europeo. Se sirven desmontadas.

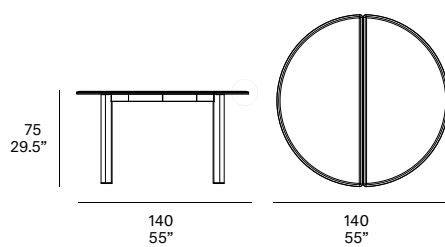

### Shipment details

Qty	1 dining table (1 box)
Volume	0,29 m <sup>3</sup> / 10.2 ft <sup>3</sup>
Gross weight	52 kg / 114.6 lb
Net weight	45 kg / 99.2 lb
Item dimensions (width x depth x height)	140 x 140 x 75 cm 55" x 55" x 29.5"

Tabletop options:

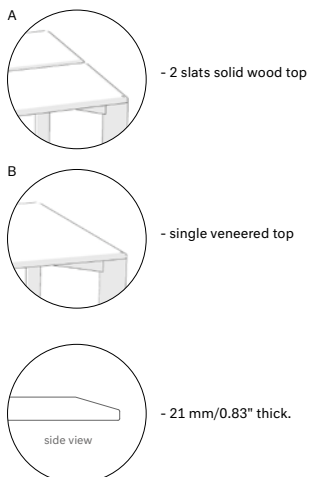

**expormim**

Expormim S.A.  
Pol. Ind. Jaime I  
46640 Moixent (Valencia) Spain  
+34 962 295 144/5  
export@expormim.com  
www.expormim.com

Expormim USA LLC  
(212) 204-8572  
usa@expormim.com  
www.expormim.com

1/2

indoor

**Solid wood / madera maciza**

---



W01 natural oak



W03 light oak



W02 white stained



W04 black stained

**Veneered / tablero chapado**

---



W01 natural oak



W03 light oak



W02 white stained



W04 black stained



indoor

# Kotai

## Square dining table / mesa cuadrada

Mario Ruiz, 2015/2021

T456 100



Structure made of solid wood profile from European oaks. Tabletop made of solid wood from European oaks with 0.83" of section. Also available in European oak veneer. Delivered unassembled.

Estructura fabricada en perfilería maciza de roble europeo. Tapa fabricada en madera maciza de roble europeo de 21 mm de sección. Existe una versión en tablero chapado de roble europeo. Se sirven desmontadas.

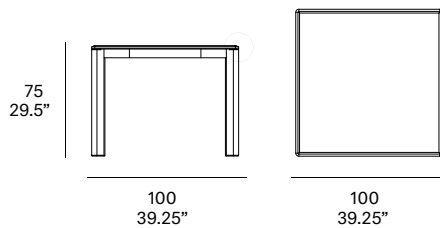

### Shipment details

Qty	1 dining table (1 box)
Volume	0,15 m <sup>3</sup> / 5.3 ft <sup>3</sup>
Gross weight	33 kg / 72.8 lb
Net weight	27 kg / 59.5 lb
Item dimensions (width x depth x height)	100 x 100 x 75 cm 39.25" x 39.25" x 29.5"

Tabletop options:



- single veneered top

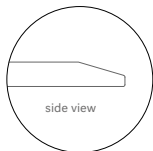

- 21 mm/0.83" thick.

**expormim**

Expormim S.A.  
Pol. Ind. Jaime I  
46640 Moixent (Valencia) Spain  
+34 962 295 144/5  
export@expormim.com  
www.expormim.com

Expormim USA LLC  
(212) 204-8572  
usa@expormim.com  
www.expormim.com

1/2

indoor

**Solid wood / madera maciza**

---



W01 natural oak



W03 light oak



W02 white stained



W04 black stained

**Veneered / tablero chapado**

---



W01 natural oak



W03 light oak



W02 white stained



W04 black stained





indoor

# Kotai

## Square dining table / mesa cuadrada

Mario Ruiz, 2015/2021

T456 120



Structure made of solid wood profile from European oaks. Tabletop made of solid wood from European oaks with 0.83" of section. Also available in European oak veneer. Delivered unassembled.

Estructura fabricada en perfilera maciza de roble europeo. Tapa fabricada en madera maciza de roble europeo de 21 mm de sección. Existe una versión en tablero chapado de roble europeo. Se sirven desmontadas.

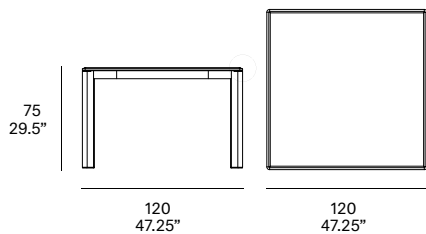

### Shipment details

Qty	1 dining table (1 box)
Volume	0,22 m <sup>3</sup> / 7.8 ft <sup>3</sup>
Gross weight	46 kg / 101.4 lb
Net weight	40 kg / 88.2 lb
Item dimensions (width x depth x height)	120 x 120 x 75 cm 47.25" x 47.25" x 29.5"

Tabletop options:



- single veneered top

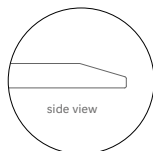

- 21 mm/0.83" thick.

**expormim**

Expormim S.A.  
Pol. Ind. Jaime I  
46640 Moixent (Valencia) Spain  
+34 962 295 144/5  
export@expormim.com  
www.expormim.com

Expormim USA LLC  
(212) 204-8572  
usa@expormim.com  
www.expormim.com

1/2

indoor

**Solid wood / madera maciza**

---



W01 natural oak



W03 light oak



W02 white stained



W04 black stained

**Veneered / tablero chapado**

---



W01 natural oak



W03 light oak



W02 white stained



W04 black stained



indoor

# Kotai

## Square dining table / mesa cuadrada

Mario Ruiz, 2015/2021

T456 140



Structure made of solid wood profile from European oaks. Tabletop made of solid wood from European oaks with 0.83" of section. Also available in European oak veneer. Delivered unassembled.

Estructura fabricada en perfilería maciza de roble europeo. Tapa fabricada en madera maciza de roble europeo de 21 mm de sección. Existe una versión en tablero chapado de roble europeo. Se sirven desmontadas.

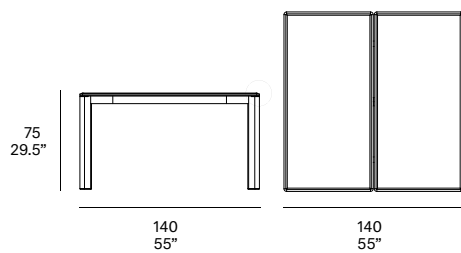

### Shipment details

Qty	1 dining table (1 box)
Volume	0,29 m <sup>3</sup> / 10.2 ft <sup>3</sup>
Gross weight	59 kg / 130.1 lb
Net weight	52 kg / 114.6 lb
Item dimensions (width x depth x height)	140 x 140 x 75 cm 55" x 55" x 29.5"

Tabletop options:

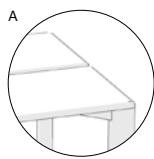

- 2 slats solid wood top

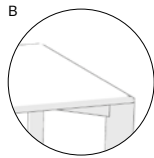

- single veneered top

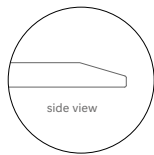

- 21 mm/0.83" thick.

**expormim**

Expormim S.A.  
Pol. Ind. Jaime I  
46640 Moixent (Valencia) Spain  
+34 962 295 144/5  
export@expormim.com  
www.expormim.com

Expormim USA LLC  
(212) 204-8572  
usa@expormim.com  
www.expormim.com

1/2

indoor

**Solid wood / madera maciza**

---



W01 natural oak



W03 light oak



W02 white stained



W04 black stained

**Veneered / tablero chapado**

---



W01 natural oak



W03 light oak



W02 white stained



W04 black stained



**expormim**

Expormim S.A.  
Pol. Ind. Jaime I  
46640 Moixent (Valencia) Spain  
+34 962 295 144/5  
export@expormim.com  
www.expormim.com

Expormim USA LLC  
(212) 204-8572  
usa@expormim.com  
www.expormim.com

indoor

# Kotai

## Rectangular dining table / mesa rectangular

Mario Ruiz, 2015/2021

T457 180



Structure made of solid wood profile from European oaks. Tabletop made of solid wood from European oaks with 0.83" of section. Also available in European oak veneer. Delivered unassembled.

Estructura fabricada en perfilera maciza de roble europeo. Tapa fabricada en madera maciza de roble europeo de 21 mm de sección. Existe una versión en tablero chapado de roble europeo. Se sirven desmontadas.

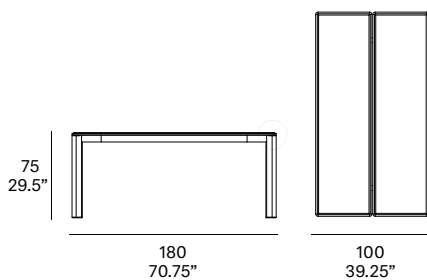

### Shipment details

Qty	1 dining table (1 box)
Volume	0,27 m <sup>3</sup> / 9.5 ft <sup>3</sup>
Gross weight	52 kg / 114.6 lb
Net weight	44 kg / 97 lb
Item dimensions (width x depth x height)	180 x 100 x 75 cm 70.75" x 39.25" x 29.5"

Tabletop options:

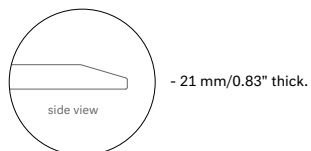
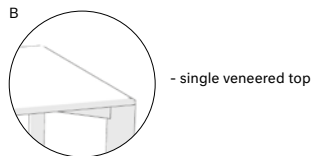
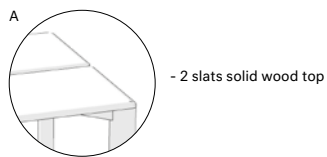

**expormim**

Expormim S.A.  
Pol. Ind. Jaime I  
46640 Moixent (Valencia) Spain  
+34 962 295 144/5  
export@expormim.com  
www.expormim.com

Expormim USA LLC  
(212) 204-8572  
usa@expormim.com  
www.expormim.com

1/2

indoor

**Solid wood / madera maciza**

---



W01 natural oak



W03 light oak



W02 white stained



W04 black stained

**Veneered / tablero chapado**

---



W01 natural oak



W03 light oak



W02 white stained



W04 black stained



**expormim**

Expormim S.A.  
Pol. Ind. Jaime I  
46640 Moixent (Valencia) Spain  
+34 962 295 144/5  
export@expormim.com  
www.expormim.com

Expormim USA LLC  
(212) 204-8572  
usa@expormim.com  
www.expormim.com

indoor

# Kotai

## Rectangular dining table / mesa rectangular

Mario Ruiz, 2015/2021

T457 200



Structure made of solid wood profile from European oaks. Tabletop made of solid wood from European oaks with 0.83" of section. Also available in European oak veneer. Delivered unassembled.

Estructura fabricada en perfilera maciza de roble europeo. Tapa fabricada en madera maciza de roble europeo de 21 mm de sección. Existe una versión en tablero chapado de roble europeo. Se sirven desmontadas.

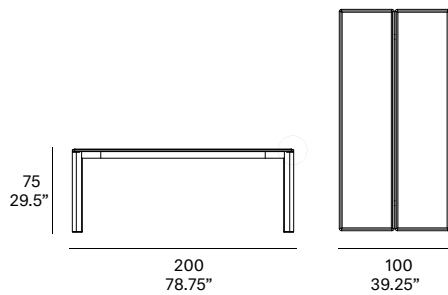

### Shipment details

Qty	1 dining table (1 box)
Volume	0,30 m <sup>3</sup> / 10.6 ft <sup>3</sup>
Gross weight	57 kg / 125.7 lb
Net weight	49 kg / 108 lb
Item dimensions (width x depth x height)	200 x 100 x 75 cm 78.75" x 39.25" x 29.5"

Tabletop options:

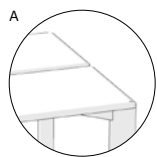

- 2 slats solid wood top

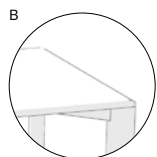

- single veneered top

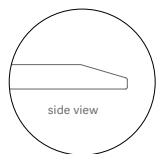

- 21 mm/0.83" thick.

**expormim**

Expormim S.A.  
Pol. Ind. Jaime I  
46640 Moixent (Valencia) Spain  
+34 962 295 144/5  
export@expormim.com  
www.expormim.com

Expormim USA LLC  
(212) 204-8572  
usa@expormim.com  
www.expormim.com

1/2

indoor

**Solid wood / madera maciza**

---



W01 natural oak



W03 light oak



W02 white stained



W04 black stained

**Veneered / tablero chapado**

---



W01 natural oak



W03 light oak



W02 white stained



W04 black stained



**expormim**

Expormim S.A.  
Pol. Ind. Jaime I  
46640 Moixent (Valencia) Spain  
+34 962 295 144/5  
export@expormim.com  
www.expormim.com

Expormim USA LLC  
(212) 204-8572  
usa@expormim.com  
www.expormim.com

2/2



indoor

# Kotai

## Rectangular dining table / mesa rectangular

Mario Ruiz, 2015/2021

T457 220



Structure made of solid wood profile from European oaks. Tabletop made of solid wood from European oaks with 0.83" of section. Also available in European oak veneer. Delivered unassembled.

Estructura fabricada en perfilera maciza de roble europeo. Tapa fabricada en madera maciza de roble europeo de 21 mm de sección. Existe una versión en tablero chapado de roble europeo. Se sirven desmontadas.

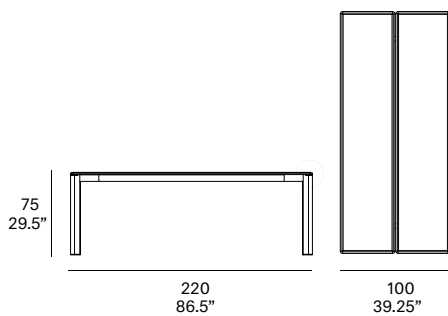

### Shipment details

Qty	1 dining table (1 box)
Volume	0,33 m <sup>3</sup> / 11.7 ft <sup>3</sup>
Gross weight	62 kg / 136.7 lb
Net weight	54 kg / 119 lb
Item dimensions (width x depth x height)	220 x 100 x 75 cm 86.5" x 39.25" x 29.5"

Tabletop options:

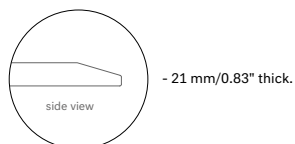
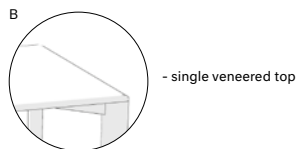
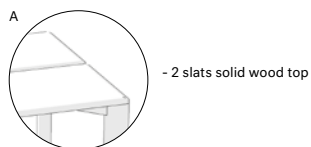

**expormim**

Expormim S.A.  
Pol. Ind. Jaime I  
46640 Moixent (Valencia) Spain  
+34 962 295 144/5  
export@expormim.com  
www.expormim.com

Expormim USA LLC  
(212) 204-8572  
usa@expormim.com  
www.expormim.com

1/2

indoor

**Solid wood / madera maciza**

---



W01 natural oak



W03 light oak



W02 white stained



W04 black stained

**Veneered / tablero chapado**

---



W01 natural oak



W03 light oak



W02 white stained



W04 black stained



**expormim**

Expormim S.A.  
Pol. Ind. Jaime I  
46640 Moixent (Valencia) Spain  
+34 962 295 144/5  
export@expormim.com  
www.expormim.com

Expormim USA LLC  
(212) 204-8572  
usa@expormim.com  
www.expormim.com

2/2

indoor

# Kotai

## Rectangular dining table / mesa rectangular

Mario Ruiz, 2015/2021

T457 240



Structure made of solid wood profile from European oaks. Tabletop made of solid wood from European oaks with 0.83" of section. Also available in European oak veneer. Delivered unassembled.

Estructura fabricada en perfilera maciza de roble europeo. Tapa fabricada en madera maciza de roble europeo de 21 mm de sección. Existe una versión en tablero chapado de roble europeo. Se sirven desmontadas.

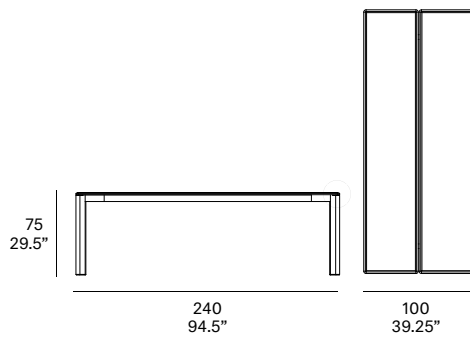

### Shipment details

Qty	1 dining table (1 box)
Volume	0,36 m <sup>3</sup> / 12.7 ft <sup>3</sup>
Gross weight	67 kg / 147.7 lb
Net weight	59 kg / 130.1 lb
Item dimensions (width x depth x height)	240 x 100 x 75 cm 94.5" x 39.25" x 29.5"

Tabletop options:

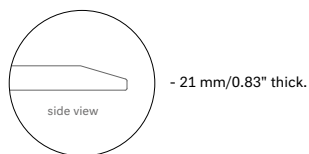
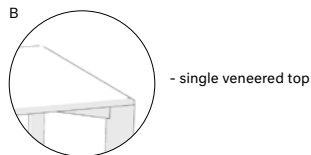
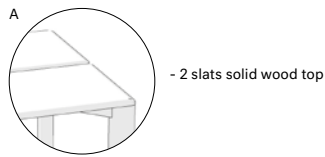

**expormim**

Expormim S.A.  
Pol. Ind. Jaime I  
46640 Moixent (Valencia) Spain  
+34 962 295 144/5  
export@expormim.com  
www.expormim.com

Expormim USA LLC  
(212) 204-8572  
usa@expormim.com  
www.expormim.com

1/2

indoor

**Solid wood / madera maciza**

---



W01 natural oak



W03 light oak



W02 white stained



W04 black stained

**Veneered / tablero chapado**

---



W01 natural oak



W03 light oak



W02 white stained



W04 black stained



indoor

# Kotai

## Rectangular dining table / mesa rectangular

Mario Ruiz, 2015/2021

T457 260



Structure made of solid wood profile from European oaks. Tabletop made of solid wood from European oaks with 0.83" of section. Also available in European oak veneer. Delivered unassembled.

Estructura fabricada en perfilera maciza de roble europeo. Tapa fabricada en madera maciza de roble europeo de 21 mm de sección. Existe una versión en tablero chapado de roble europeo. Se sirven desmontadas.

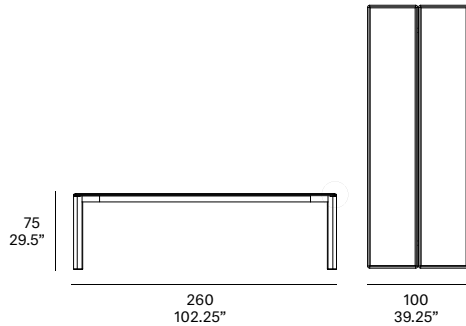

### Shipment details

Qty	1 dining table (1 box)
Volume	0,39 m <sup>3</sup> / 13.4 ft <sup>3</sup>
Gross weight	72 kg / 158.7 lb
Net weight	64 kg / 141.1 lb
Item dimensions (width x depth x height)	260 x 100 x 75 cm 102.25" x 39.25" x 29.5"

Tabletop options:

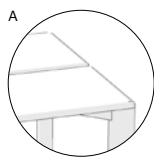

- 2 slats solid wood top

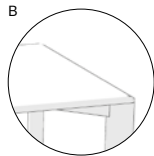

- single veneered top

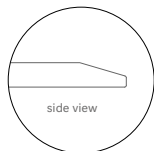

- 21 mm/0.83" thick.

**expormim**

Expormim S.A.  
Pol. Ind. Jaime I  
46640 Moixent (Valencia) Spain  
+34 962 295 144/5  
export@expormim.com  
www.expormim.com

Expormim USA LLC  
(212) 204-8572  
usa@expormim.com  
www.expormim.com

1/2

indoor

**Solid wood / madera maciza**

---



W01 natural oak



W03 light oak



W02 white stained



W04 black stained

**Veneered / tablero chapado**

---



W01 natural oak



W03 light oak



W02 white stained



W04 black stained



indoor

# Kotai

## Rectangular expandable dining table / mesa rectangular extensible

Mario Ruiz, 2015/2021

T460

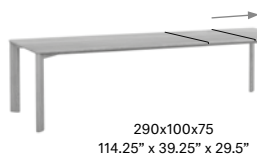
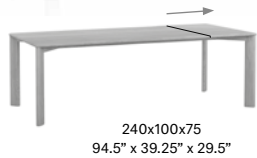

Structure made of solid wood profile from European oaks.  
Tabletop made of European oak veneer with 0.83" of section.  
Delivered unassembled.

Estructura fabricada en perfilería maciza de roble europeo. Tapa  
fabricada en tablero chapado de roble europeo de 21 mm de  
sección. Se sirven desmontadas.

### Shipment details

Qty	1 dining table (1 box)
Volume	0,29 m <sup>3</sup> / 10.2 ft <sup>3</sup>
Gross weight	105,5 kg / 232.6 lb
Net weight	88 kg / 194 lb

Item dimensions (width x depth x height)	190 x 100 x 75 cm 74.75" x 39.25" x 29.5"
	240 x 100 x 75 cm 94.5" x 39.25" x 29.5"
	290 x 100 x 75 cm 114.25" x 39.25" x 29.5"

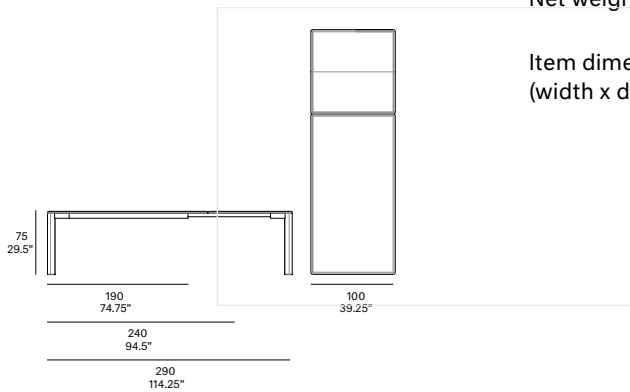

Tabletop options:

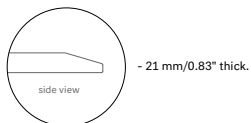
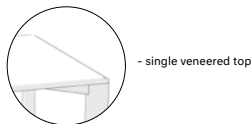

**expormim**

Expormim S.A.  
Pol. Ind. Jaime I  
46640 Moixent (Valencia) Spain  
+34 962 295 144/5  
export@expormim.com  
www.expormim.com

Expormim USA LLC  
(212) 204-8572  
usa@expormim.com  
www.expormim.com

1/2

indoor

**Solid wood / madera maciza**

**Legs / patas**



W01 natural oak



W03 light oak



W02 white stained



W04 black stained

**Veneered / tablero chapado**

**Tabletop/ tapa**



W01 natural oak



W03 light oak



W02 white stained



W04 black stained





indoor

# Kotai

## Rectangular high dining table / mesa rectangular alta

Mario Ruiz, 2015/2021

T477 180



Structure made of solid wood profile from European oaks. Tabletop made of solid wood from European oaks with 0.83" of section. Also available in European oak veneer. Delivered unassembled.

Estructura fabricada en perfilera maciza de roble europeo. Tapa fabricada en madera maciza de roble europeo de 21 mm de sección. Existe una versión en tablero chapado de roble europeo. Se sirven desmontadas.

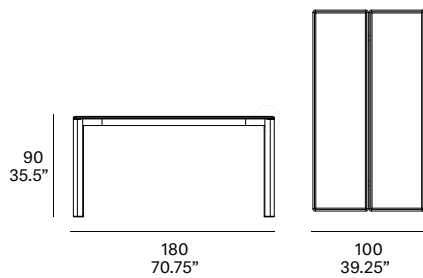

### Shipment details

Qty	1 dining table (1 box)
Volume	0,27 m <sup>3</sup> / 9.5 ft <sup>3</sup>
Gross weight	55 kg / 121.3 lb
Net weight	47 kg / 103.6 lb
Item dimensions (width x depth x height)	180 x 100 x 90 cm 70.75" x 39.25" x 35.5"

Tabletop options:

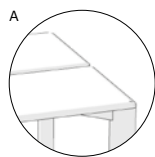

- 2 slats solid wood top  
21 mm/0.83" thick.

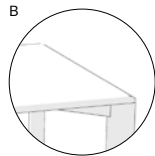

- single veneered top  
21 mm/0.83" thick.

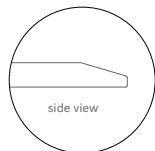

- 21 mm/0.83" thick.

**expormim**

Expormim S.A.  
Pol. Ind. Jaime I  
46640 Moixent (Valencia) Spain  
+34 962 295 144/5  
export@expormim.com  
www.expormim.com

Expormim USA LLC  
(212) 204-8572  
usa@expormim.com  
www.expormim.com

1/2

indoor

**Solid wood / madera maciza**

---



W01 natural oak



W03 light oak



W02 white stained



W04 black stained

**Veneered / tablero chapado**

---



W01 natural oak



W03 light oak



W02 white stained



W04 black stained



indoor

# Kotai

## Rectangular high dining table / mesa rectangular alta

Mario Ruiz, 2015/2021

T477 200



Structure made of solid wood profile from European oaks. Tabletop made of solid wood from European oaks with 0.83" of section. Also available in European oak veneer. Delivered unassembled.

Estructura fabricada en perfilera maciza de roble europeo. Tapa fabricada en madera maciza de roble europeo de 21 mm de sección. Existe una versión en tablero chapado de roble europeo. Se sirven desmontadas.

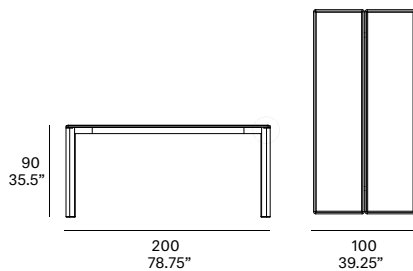

### Shipment details

Qty	1 dining table (1 box)
Volume	0,30 m <sup>3</sup> / 10.6 ft <sup>3</sup>
Gross weight	60 kg / 132.3 lb
Net weight	52 kg / 114.6 lb
Item dimensions (width x depth x height)	200 x 100 x 90 cm 78.75" x 39.25" x 35.5"

Tabletop options:

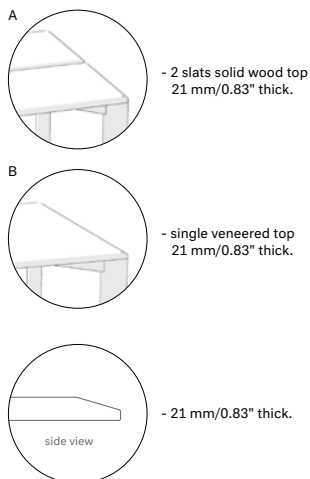

**expormim**

Expormim S.A.  
Pol. Ind. Jaime I  
46640 Moixent (Valencia) Spain  
+34 962 295 144/5  
export@expormim.com  
www.expormim.com

Expormim USA LLC  
(212) 204-8572  
usa@expormim.com  
www.expormim.com

1/2

indoor

**Solid wood / madera maciza**

---



W01 natural oak



W03 light oak



W02 white stained



W04 black stained

**Veneered / tablero chapado**

---



W01 natural oak



W03 light oak



W02 white stained



W04 black stained



**expormim**

Expormim S.A.  
Pol. Ind. Jaime I  
46640 Moixent (Valencia) Spain  
+34 962 295 144/5  
export@expormim.com  
www.expormim.com

Expormim USA LLC  
(212) 204-8572  
usa@expormim.com  
www.expormim.com

indoor

# Kotai

## Rectangular high dining table / mesa rectangular alta

Mario Ruiz, 2015/2021

T477 220



Structure made of solid wood profile from European oaks. Tabletop made of solid wood from European oaks with 0.83" of section. Also available in European oak veneer. Delivered unassembled.

Estructura fabricada en perfilera maciza de roble europeo. Tapa fabricada en madera maciza de roble europeo de 21 mm de sección. Existe una versión en tablero chapado de roble europeo. Se sirven desmontadas.

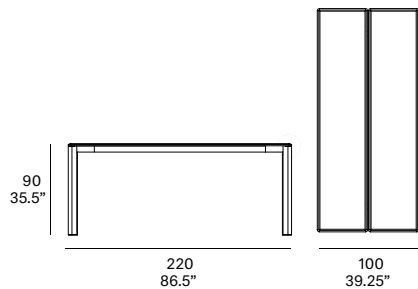

### Shipment details

Qty	1 dining table (1 box)
Volume	0,33 m <sup>3</sup> / 11.7 ft <sup>3</sup>
Gross weight	65 kg / 143.3 lb
Net weight	57 kg / 125.7 lb
Item dimensions (width x depth x height)	220 x 100 x 90 cm 86.5" x 39.25" x 35.5"

Tabletop options:

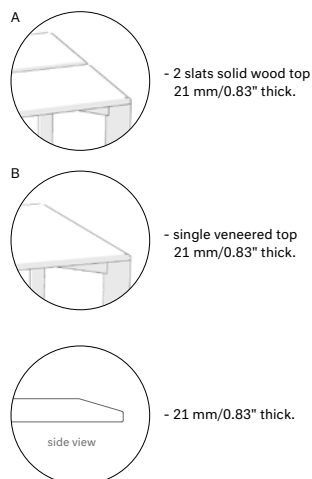

**expormim**

Expormim S.A.  
Pol. Ind. Jaime I  
46640 Moixent (Valencia) Spain  
+34 962 295 144/5  
export@expormim.com  
www.expormim.com

Expormim USA LLC  
(212) 204-8572  
usa@expormim.com  
www.expormim.com

1/2

indoor

**Solid wood / madera maciza**

---



W01 natural oak



W03 light oak



W02 white stained



W04 black stained

**Veneered / tablero chapado**

---



W01 natural oak



W03 light oak



W02 white stained



W04 black stained



indoor

# Kotai

## Rectangular high dining table / mesa rectangular alta

Mario Ruiz, 2015/2021

T477 240



Structure made of solid wood profile from European oaks. Tabletop made of solid wood from European oaks with 0.83" of section. Also available in European oak veneer. Delivered unassembled.

Estructura fabricada en perfilera maciza de roble europeo. Tapa fabricada en madera maciza de roble europeo de 21 mm de sección. Existe una versión en tablero chapado de roble europeo. Se sirven desmontadas.

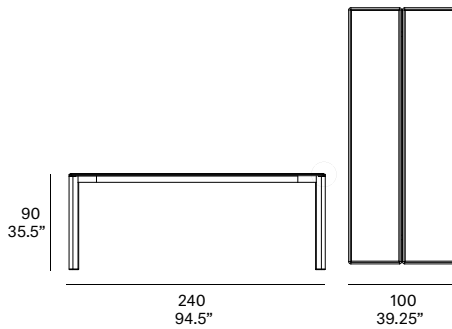

### Shipment details

Qty	1 dining table (1 box)
Volume	0,36 m <sup>3</sup> / 12.7 ft <sup>3</sup>
Gross weight	70 kg / 154.3 lb
Net weight	62 kg / 136.7 lb
Item dimensions (width x depth x height)	240 x 100 x 90 cm 94.5" x 39.25" x 35.5"

#### Tabletop options:

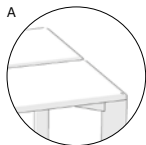

- 2 slats solid wood top  
21 mm/0.83" thick.

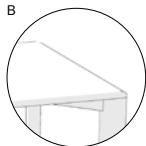

- single veneered top  
21 mm/0.83" thick.

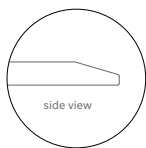

- 21 mm/0.83" thick.

**expormim**

Expormim S.A.  
Pol. Ind. Jaime I  
46640 Moixent (Valencia) Spain  
+34 962 295 144/5  
export@expormim.com  
www.expormim.com

Expormim USA LLC  
(212) 204-8572  
usa@expormim.com  
www.expormim.com

1/2

indoor

**Solid wood / madera maciza**

---



W01 natural oak



W03 light oak



W02 white stained



W04 black stained

**Veneered / tablero chapado**

---



W01 natural oak



W03 light oak



W02 white stained



W04 black stained



**expormim**

Expormim S.A.  
Pol. Ind. Jaime I  
46640 Moixent (Valencia) Spain  
+34 962 295 144/5  
export@expormim.com  
www.expormim.com

Expormim USA LLC  
(212) 204-8572  
usa@expormim.com  
www.expormim.com



indoor

# Kotai

## Rectangular high dining table / mesa rectangular alta

Mario Ruiz, 2015/2021

T477 260



Structure made of solid wood profile from European oaks. Tabletop made of solid wood from European oaks with 0.83" of section. Also available in European oak veneer. Delivered unassembled.

Estructura fabricada en perfilera maciza de roble europeo. Tapa fabricada en madera maciza de roble europeo de 21 mm de sección. Existe una versión en tablero chapado de roble europeo. Se sirven desmontadas.

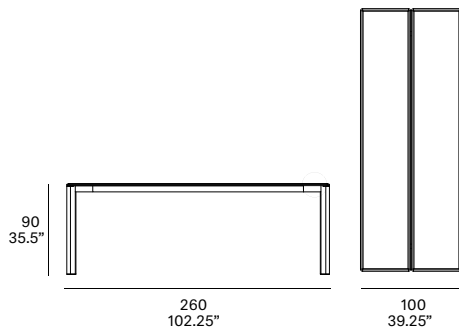

### Shipment details

Qty	1 dining table (1 box)
Volume	0,38 m <sup>3</sup> / 13.4 ft <sup>3</sup>
Gross weight	75 kg / 165.3 lb
Net weight	67 kg / 147.7 lb
Item dimensions (width x depth x height)	260 x 100 x 90 cm 102.25" x 39.25" x 35.5"

Tabletop options:

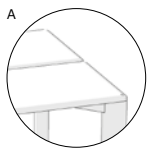

- 2 slats solid wood top  
21 mm/0.83" thick.

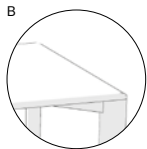

- single veneered top  
21 mm/0.83" thick.

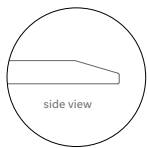

- 21 mm/0.83" thick.

**expormim**

Expormim S.A.  
Pol. Ind. Jaime I  
46640 Moixent (Valencia) Spain  
+34 962 295 144/5  
export@expormim.com  
www.expormim.com

Expormim USA LLC  
(212) 204-8572  
usa@expormim.com  
www.expormim.com

1/2

indoor

**Solid wood / madera maciza**

---



W01 natural oak



W03 light oak



W02 white stained



W04 black stained

**Veneered / tablero chapado**

---



W01 natural oak



W03 light oak



W02 white stained



W04 black stained



**expormim**

Expormim S.A.  
Pol. Ind. Jaime I  
46640 Moixent (Valencia) Spain  
+34 962 295 144/5  
export@expormim.com  
www.expormim.com

Expormim USA LLC  
(212) 204-8572  
usa@expormim.com  
www.expormim.com